

Si-APD-Array SAH1L16-Series

Description

The SAH1L16-Series is a linear Si-APD-array with 16 elements in a LCC44 package with protective window. Responsivity is optimised for 850 nm.

Features

- 16 element APD array
- Very narrow gap
- High quantum efficiency
- Low noise, high speed
- 620 μm x 190 μm active area per element
- Wide operating temperature range
- Low crosstalk

Applications

- Ranging
- LIDAR ACC
- Laser scanner

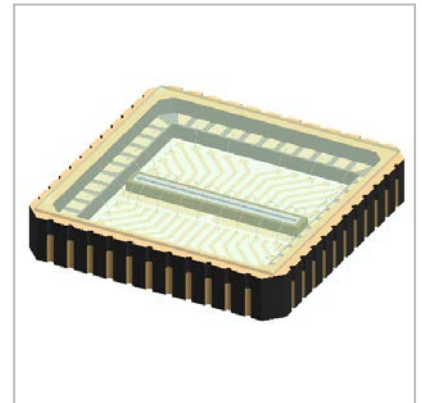

Electro-Optical Characteristics, $T_a = 25\text{ }^\circ\text{C}$

Parameter	Condition	Min	Typ	Max	Unit
# of elements		16			
Active area		620 x 190			μm
Gap		40			μm
Dark current I_d	$M = 100, \lambda = 905\text{ nm}$, per element		4	10	nA
Capacitance, C	$M = 100$, per element		3		pF
Responsivity, R_l	$M = 100, \lambda = 905\text{ nm}$	40	50		
Rise time, t_r	$M = 100, \lambda = 905\text{ nm}, R_l = 50\text{ Ohms}$		1000		psec
Breakdown voltage, V_{BR}	$I_R = 10\text{ }\mu\text{A}$	80	150	200	V
Temperature coefficient	$I_R = 10\text{ }\mu\text{A}$		0.44		V/K
Crosstalk	$\lambda = 905\text{ nm}$		50		dB
Dark current uniformity	$M = 100$		± 5	± 20	%
Photo current uniformity	$M = 100, \lambda = 905\text{ nm}$		± 5	± 20	%

Absolute Maximum Ratings

Parameter		Min	Max	Unit
Storage temperature		-55	100	$^\circ\text{C}$
Operating temperature		-40	85	
Soldering (15s)			260	
Reverse current (Peak)	CW		0.200	mA
	1s Pulse		1	
Forward current (Avg)	CW		10	
	1s Pulse		50	
Max total power dissipation			60	mW

Curves

Fig. 1: Spectral Response

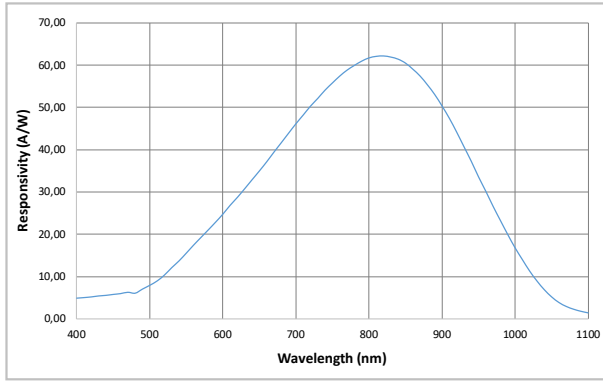

Fig. 2: Quantum Efficiency

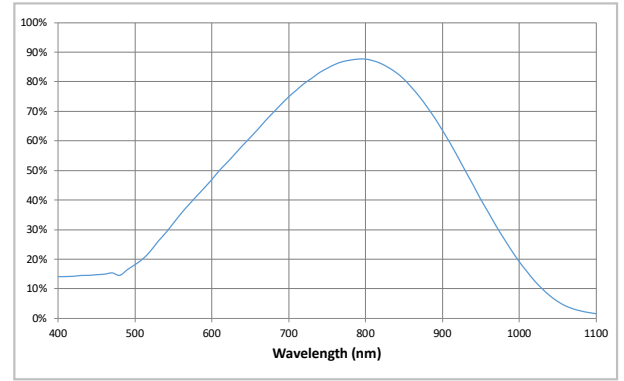

Fig. 3: Multiplication

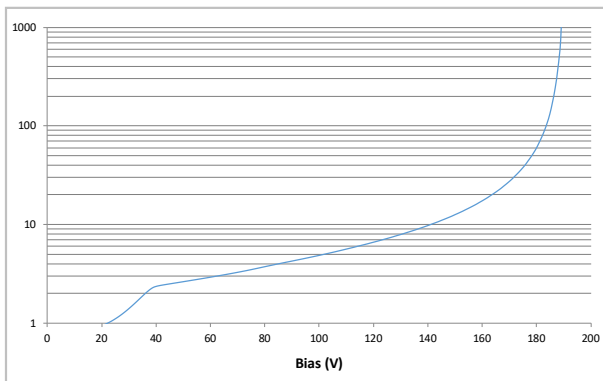

Fig. 4: Current vs. Reverse Voltage

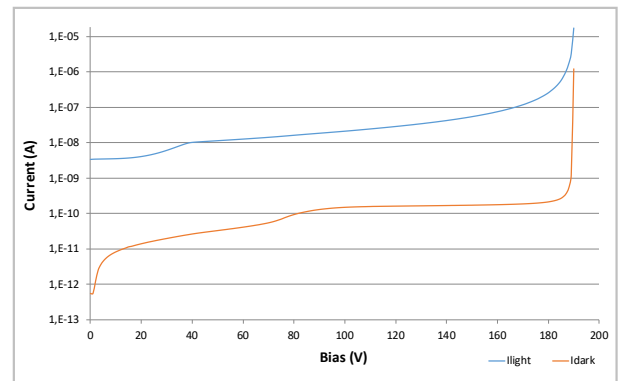

Fig. 5: Capacitance vs. Reverse Voltage

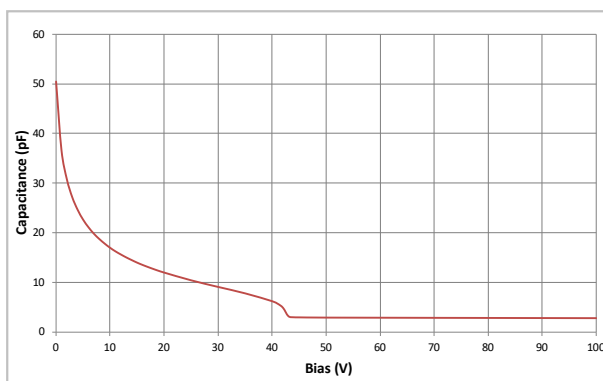
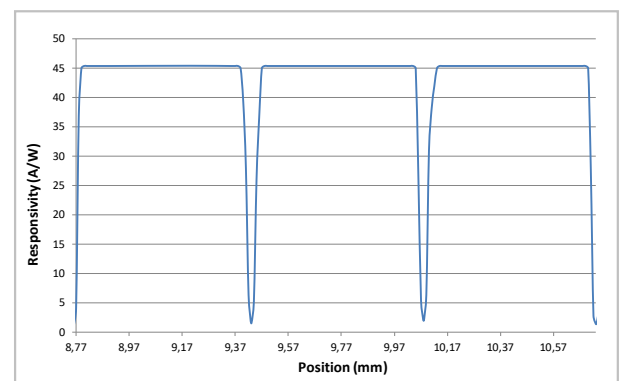
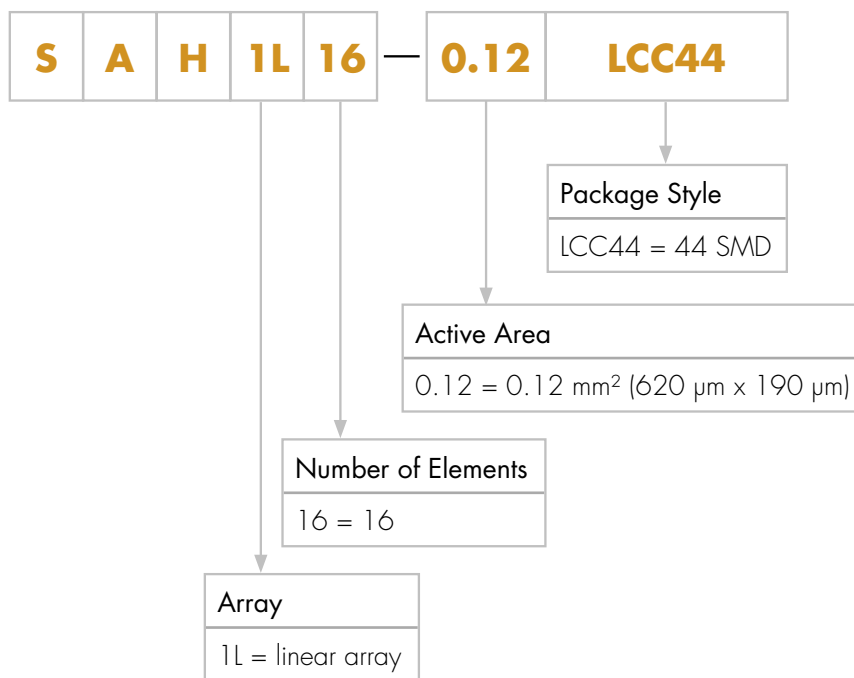

Fig. 6: Spot Scan



Product Number Designation



Package Drawings

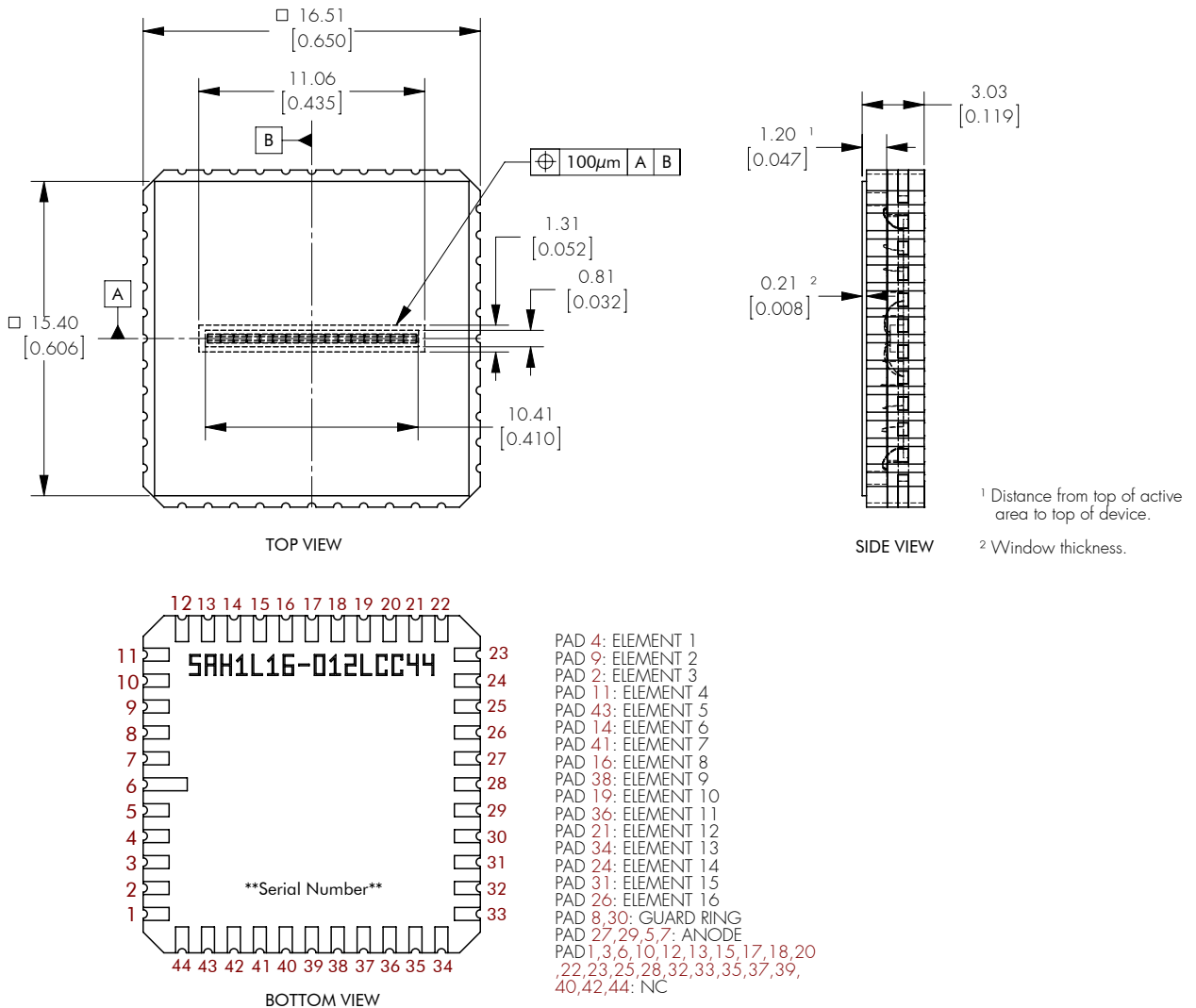

Product Changes

LASER COMPONENTS reserves the right to make changes to the product(s) or information contained herein without notice.
 No liability is assumed as a result of their use or application.

Ordering Information

Products can be ordered directly from LASER COMPONENTS or its representatives. For a complete listing of representatives, visit our website at www.lasercomponents.com
 Custom designed products are available on request.